

AUTOMOTIVE & TIRE PRODUCTION LINE

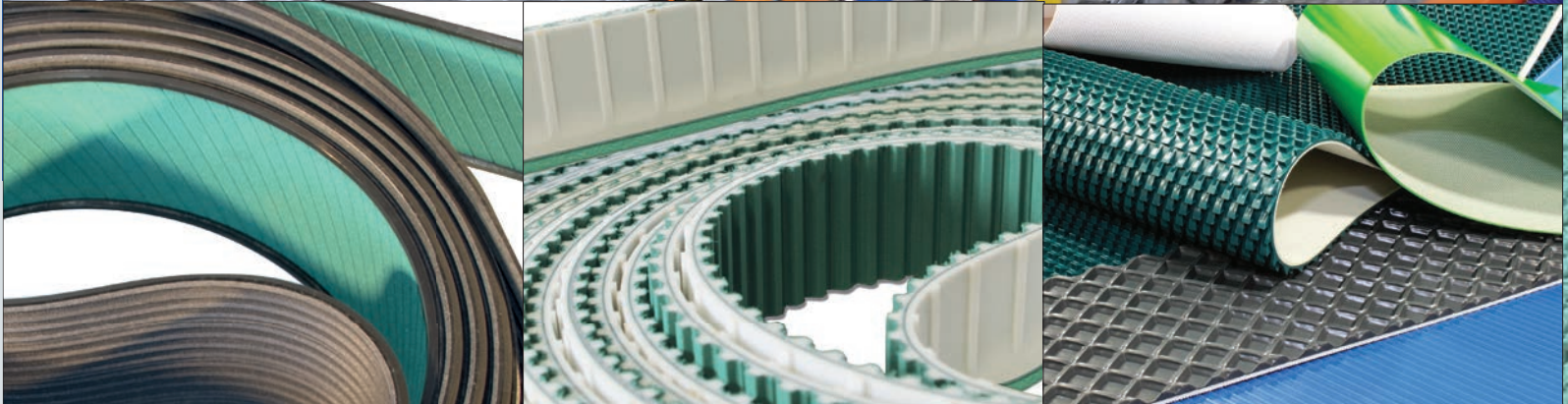
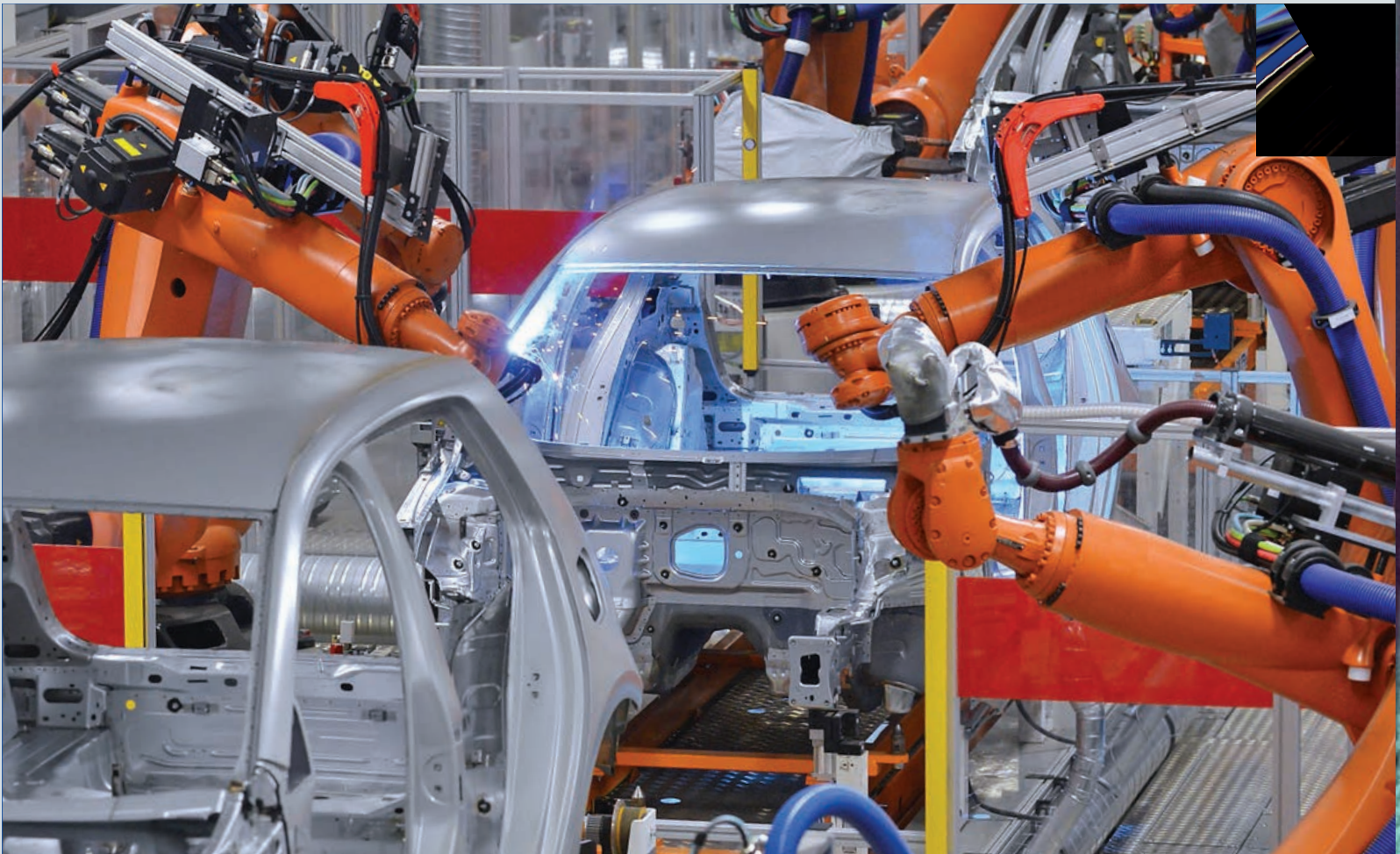

MEGADYNE

Automotive & tire production line

The **Megadyne Group**, founded almost 60 years ago, is a global organization specializing in the development and manufacture of a variety of industrial belt systems. Ranging from power transmission, to conveyor belting, from linear positioning to material handling.

Megadyne has a worldwide presence, with production and distribution centers in Europe, the Americas, Africa, Asia and the Middle East. We can offer local recommendations, tailored to your individual requirements. This ensures custom-made solutions, delivered on time.

With many years' experience in Automotive and Tire manufacturing sectors, supported by ongoing, research, Megadyne offers a wide range and depth of products. These all combine, to allow the widest, most flexible approach to providing clients with a customised solution.

From our wide range of products, in rubber, PU and fabric, Megadyne can supply innovative solutions to the market. Megadynes polyurethane ranges are able to provide open ended belts with customised cords, for high traction resistance and superior flexibility. This guarantees the best life cycle and precision in the field. Megadyne R&D has developed several different solutions with a wide range of materials able to stand extreme conditions and aggressive chemical attack. Megadyne is able to manufacture silicone free timing belts.

Belt features

MEGADYNE® ISORAN SYNCHRONOUS RPP

SUPPLIED AS	Endless
LENGTH	248 - 4956 mm
WIDTH	12-170 mm
THICKNESS	5,4 - 9,7 mm
Pitch	RPP8 - RPP14
Tensioning member	Fiberglass
Advantage & characteristic	High stability and resistance

MEGADYNE® PLATINUM

SUPPLIED AS	Endless
LENGTH	248 - 4956 mm
WIDTH	12-170 mm
THICKNESS	5,4 - 9,7 mm
Pitch	RPP8 - RPP14
Tensioning member	Dual Core
Advantage & characteristic	Highest power transmission

MEGADYNE® MEGAPAIN

SUPPLIED AS	Endless
LENGTH	248 - 4956 mm
WIDTH	12-170 mm
THICKNESS	5,4 - 9,7 mm
Pitch	RPP8 - PLT14
Tensioning member	Fiberglass/Dual Cord
Advantage & characteristic	Silicone and contaminants free

MEGADYNE® V-BELT

SUPPLIED AS	Endless
LENGTH	450 - 12530
Sections	SPZ/SPA/SPB/SPC/XPZ/XPA/XPB/XPC
Compound	EPDM - SBR
Advantage & characteristic	Long lifetime and small pulley diameters

MEGADYNE® POLYURETHANE WIDE BELTS

SUPPLIED AS	Open end rolls, joined
LENGTH	from 1.2 m
WIDTH	200 - 500 mm
Pitch	T5-T10/H
Tensioning member	Kevlar cord
Coatings	NFT - NFB
Advantage & characteristic	High precision and convey capability

MEGADYNE® SPECIALTY

SUPPLIED AS	Open End Rolls, Endless, Joined
LENGTH	0,5 - 100 m
WIDTH	6 - 150 mm
Pitch	T5-T10-T20-AT5-AT10-AT20-RPP8-RPP14-HTD8 HTD14
Tensioning member	Standard steel/HF Steel/HP steel/HPF steel/Kevlar
Covers & special reworking	Avafc/Tenax/Red Grip/NFT/Grinding/Holes
Advantage & characteristic	Custom made solutions for high performances level

MEGADYNE® POLYURETHANE TIMING BELTS

SUPPLIED AS	Open End Rolls, Endless, Joined
LENGTH	Megalinear: 0,5 - 100 m Megaflex: 1,5 - 22,77 m
WIDTH	6 - 150 mm
Pitch	T5-T10-T20-AT5-AT10-AT20-RPP8-RPP14-HTD8 HTD14-TG10-ATG10-TG20-ATG20
Tensioning member	Standard steel/HF Steel/HP steel/HPF steel/Kevlar
Coatings	Avafc/Tenax/Red Grip/NFT
Advantage & characteristic	High resistance belts available also in silicone free compounds

MEGADYNE® MEGALINEAR P3-P4

SUPPLIED AS	Open End Rolls
LENGTH	100 m
WIDTH	30 - 120 mm
THICKNESS	3 - 4 mm
Tensioning member	Standard steel/HP steel
Advantage & characteristic	Extreme tension resistance for industrial lifting systems

MEGADYNE® MEGALINEAR PS4.8

SUPPLIED AS	Open End Rolls
LENGTH	1900 - 22770 mm
WIDTH	80 mm
Pitch	PS4.8
Tensioning member	Steel cord
Coatings	NFT
Advantage & characteristic	High resistance to wearing and reduction of the maintenance costs

MEGADYNE® ACCU-LINK

SUPPLIED AS	Rolls
LENGTH	7 - 30 m
Sections	Z/3L - A/4L - B/5L - C
Fabric	Multilayer woven polyeste
Advantage & characteristic	Accu-Link can be assembled without any tool and in a matter of seconds.

These are particularly critical in the automotive body painting process.

Our depth and breadth of experience, achieved during decades of partnership with automotive and tire manufacturers, gives Megadyne the capability and experience to manufacture specially fabricated belts, for vacuum, magnetic applications and the transport of the raw rubber stock.

Our rubber drive belts are available in many different compounds and constructions, according to your drive requirements.

The belts are available in the RPP profile that provides high power capacity with low noise and smooth running. Megadyne can supply: Isoran standard, Silver, Gold and Platinum.

All Megadyne products are certified to conform to all the relevant International standards.

Conveyor belts features

SAMPLA® FABCON

	B31 (3F/14 PG35 U0/U0)	R13 (2LR/6 TR10 U0/00 AS FA)	R16 (2R-RX/14 TR15 00/00 AS FA)	R30 (3FC/8 TR30 00/00 FA)
TOTAL THICKNESS APPROX (mm)	3,5	1	1,5	3
WEIGHT APPROX. (kg/m ²)	4	1,1	1,8	3,5
EFFECTIVE PULL AT 1% ELONGATION (N/mm.width)	14	6	14	8
MAX.BELT WIDTH WITHOUT LONGITUDINAL seam(mm.)	3000	3000	3000	3000
D. MIN APPROX. (mm.)	80	10	40	60
PERMITTED OPERATING TEMPERATURE (C°)	-10 /+80	-10 /+80	-10 /+80	-10 /+80
RESISTENT,OIL AND GREASE	Yes	Yes	Limited	Limited

SAMPLA® PUCON

	PN20/A (2R/13 B25 00/ U05A AR)	PN30/A (3R/50 B25 00/ U04A AR)	P24/A/DG (2R-RX/14 DG40 U0/U20A AS FA AR)
TOTAL THICKNESS APPROX (mm)	2,4	2,6	4
WEIGHT APPROX. (kg/m ²)	2,75	2,9	4,8
EFFECTIVE PULL AT 1% ELONGATION (N/mm.width)	13	50	14
MAX.BELT WIDTH WITHOUT LONGITUDINAL seam(mm.)	3200	3200	3000
D. MIN APPROX. (mm.)	80	100	70
PERMITTED OPERATING TEMPERATURE (C°)	-30 /+80	-30 /+80	-30 /+80
RESISTENT,OIL AND GREASE	Yes	Yes	Yes

SAMPLA® FELTCON

	SAM 040/A (1K/17 GR40 00/00 AS)
TOTAL THICKNESS APPROX (mm)	4
WEIGHT APPROX. (kg/m ²)	2,5
EFFECTIVE PULL AT 1% ELONGATION (N/mm.width)	17
MAX.BELT WIDTH WITHOUT LONGITUDINAL seam(mm.)	2000
D. MIN APPROX. (mm.)	80
PERMITTED OPERATING TEMPERATURE (C°)	-10 /+120
RESISTENT,OIL AND GREASE	Yes

SAMPLA® PVCCON

	U35 (3R/16 PG45 00/ V15 AS)	U91V (3F/50 PG70 V0/V)
TOTAL THICKNESS APPROX (mm)	4,5	7
WEIGHT APPROX. (kg/m ²)	5,4	7,6
EFFECTIVE PULL AT 1% ELONGATION (N/mm.width)	16	50
MAX.BELT WIDTH WITHOUT LONGITUDINAL seam(mm.)	3000	2400
D. MIN APPROX. (mm.)	150	350
PERMITTED OPERATING TEMPERATURE (C°)	-10 /+80	-10 /+80
RESISTENT,OIL AND GREASE	Yes	Yes

Sheet Metal Processing

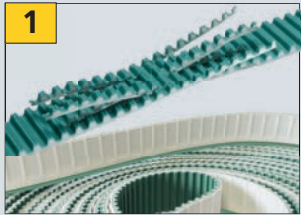
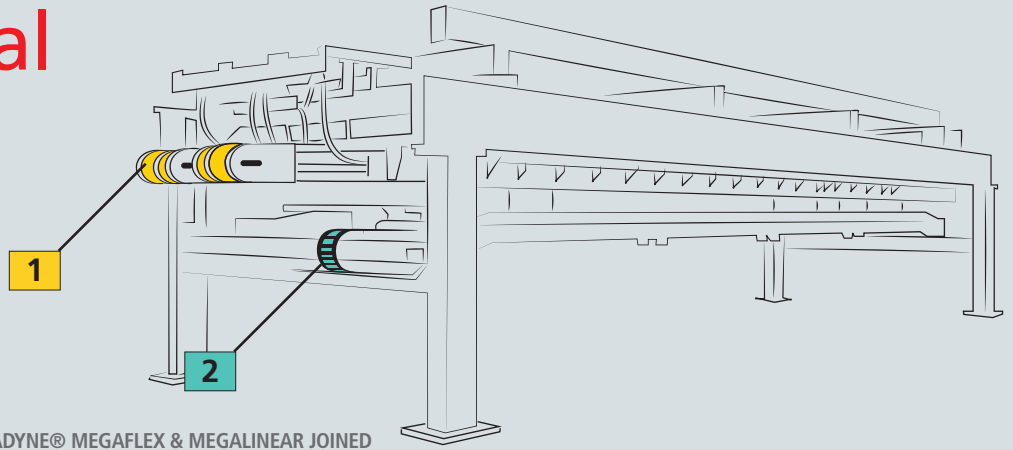

MEGADYNE® MEGAFLEX & MEGALINEAR JOINED

- **Megaflex** are suitable as truly endless belts with thermoplastic polyurethane and continuous spiral cord
- **Megalinear Joined** are open end joined belts in thermoplastic polyurethane and S & Z parallel cord
- Available with special polyurethane and covers for oil, chemical resistance and high grip requirements
- Can be reworked with custom-made grinding operations. Suitable for high speed conveyors in high capacity production areas
- Non marking surface materials

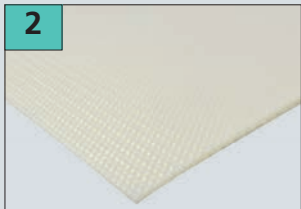

SAMPLA® FABCON

- B31 (3F/14 PG35 U0/U0) - R13 (2LR/6 TR10 U0/00 AS FA) - R16 (2R-RX/14 TR15 00/00 AS FA) - R30 (3FC/8 TR30 00/00 FA)
- Abrasion and cut resistant
- Using as accumulating conveyor
- Conveyor belts with excellent release properties suitable for rubber mixture conveying
- Available with cotton fabric, polyester fabric
- Impregnations if required

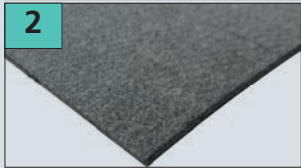

SAMPLA® FELTCON

- High temperature resistant
- Used for conveying steel sheets before the painting and pressing stages
- Manufactured of needle felt that provides a cut resistant soft surface that ensure the steel sheets are not damaged

Robotic Manufacturing

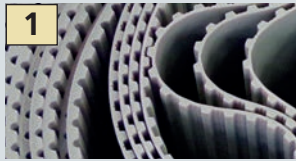
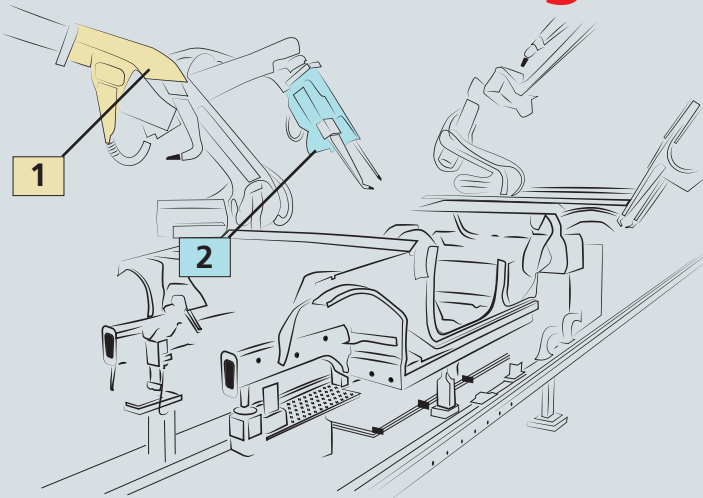

MEGADYNE® MEGAPOWER

- Truly endless belt manufactured in thermoset polyurethane with spiral cord.
- High positioning precision



MEGADYNE® ISORAN

- Endless rubber belts
- Spiral fiberglass cord for high speed
- High precision drives

Glass tempering line and storage

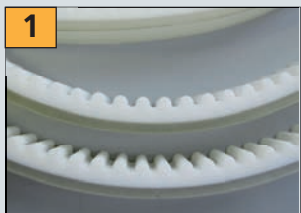

MEGADYNE® POLYURETHANE NO MARKING TIMING BELTS

- Polyurethane Endless and open end belt
- Non marking coating
- Smooth drive
- AVAFC (urethane) and Z (Foam urethane) cover coating provide high friction

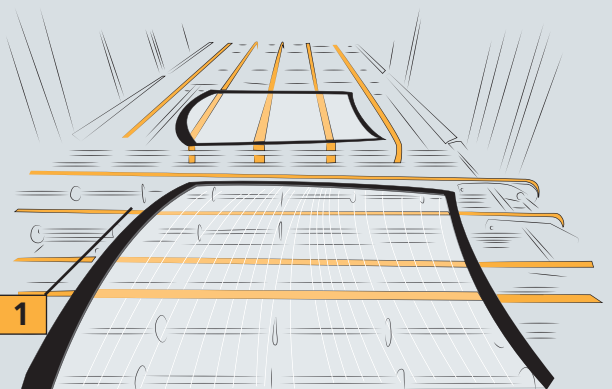

Car chassis assembly and handling

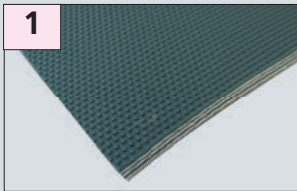
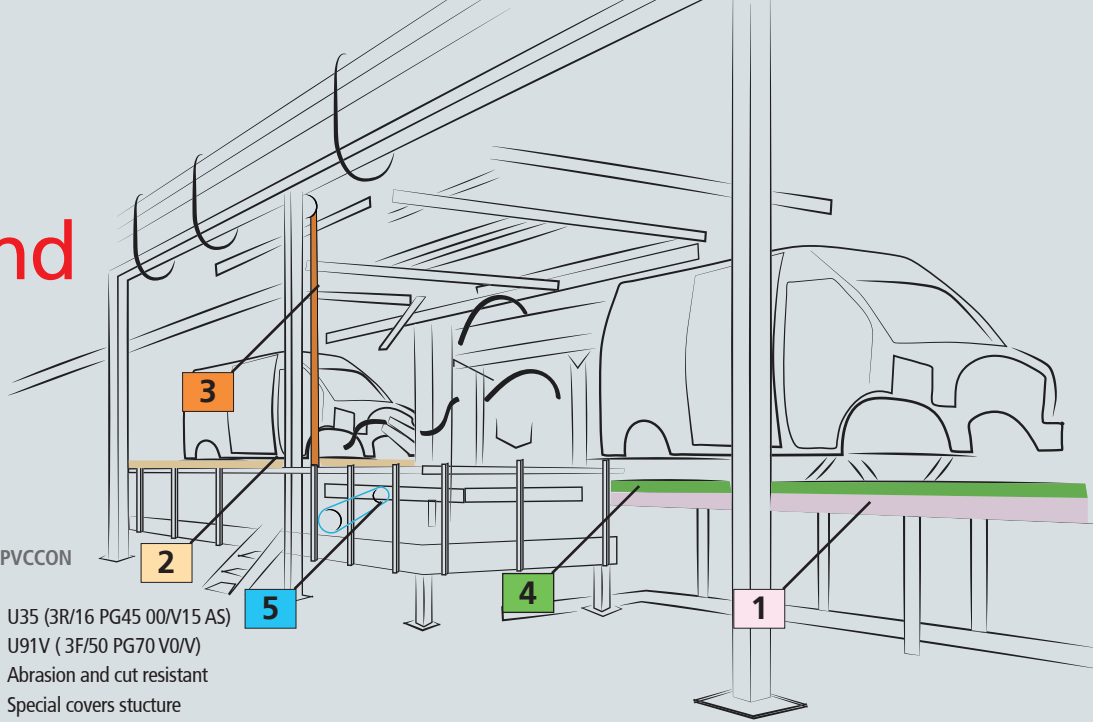

SAMPLA®PVCCON

- U35 (3R/16 PG45 00/V15 AS)
- U91V (3F/50 PG70 V0/V)
- Abrasion and cut resistant
- Special covers structure



SAMPLA® PUCON

- PN20/A (2R/13 B25 00/U05A AR) - PN30/A (3R/50 B25 00/U04A AR) - P24/A/DG (2R-RX/14 DG40 U0/U20A AS FA AR)
- Abrasion and cut resistant
- Low noise fabric back
- Permanently antistatic and oil resistant

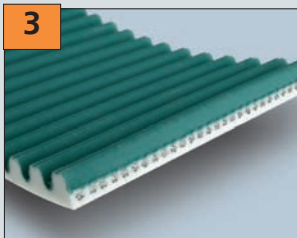

MEGADYNE® MEGALINEAR

- The frameworks lifting systems are commonly equipped with Megalinear open end belts
- Designed to ensure precise position on heavy loads
- The most suitable belts are RPP14, RPP14 XP
- P3 and P4 have been developed for the vertical lifting system and are available in several widths and with different tensile member

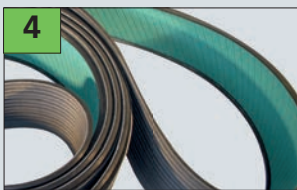

MEGADYNE® MEGAFLEX FLAT BELT

- PS4.8 have been specifically developed for chassis production
- Truly endless belts with high resistance steel cord
- Suitable for skid conveyors applications



MEGADYNE® PLATINUM

- PLATINUM represents the highest level of power transmission performances
- High resistance and long life cycles, even in the most extreme operating conditions

Fan System



MEGADYNE® V-BELT

- Grinded sidewalls for smooth-running operation, with no vibrations and reduced noise levels
- The longer and reliable service life reduces the material and labor cost for drive maintenance

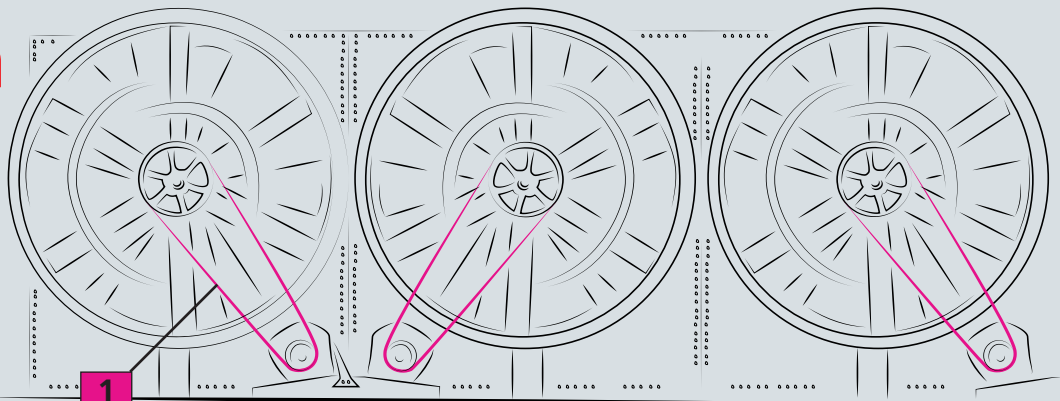

MEGADYNE® ACCU-LINK

- Link-belt, created and developed as an alternative to classical rubber V-belts
- Made with a polyurethane elastomer reinforced by a multilayer woven polyester fabric
- Easy installation; reduced downtime
- Low vibration level

Painting Lines

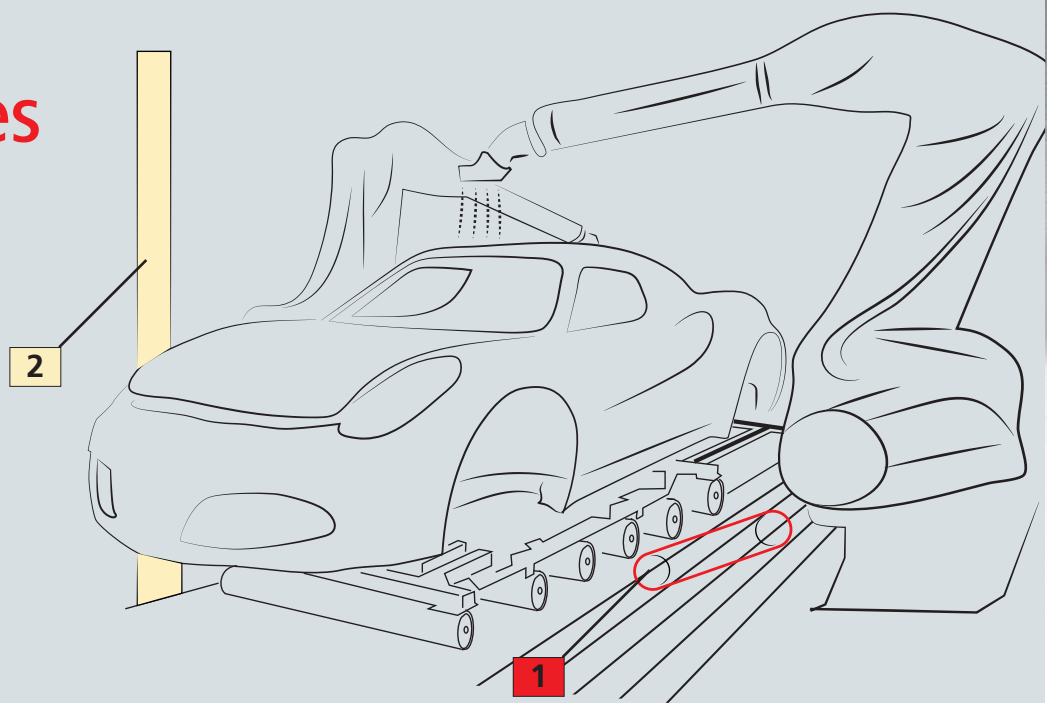

MEGADYNE® MEGAPAINT

- Special compounded power transmission belts that are able to conform to the strict requirements related to non-contamination
- Supplied in special sealed packaging
- Silicone Free

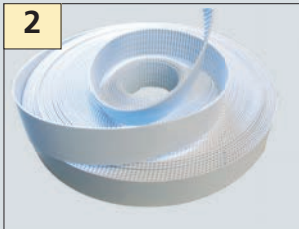

MEGADYNE® MEGALINEAR SILICON FREE

- All the open ended and endless belts in thermoplastic polyurethane. Available in silicon free material and in different compounds, according to the requirements of the painting process
- Contaminant free

Tire Manufacturing

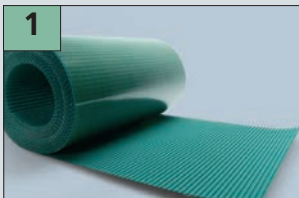
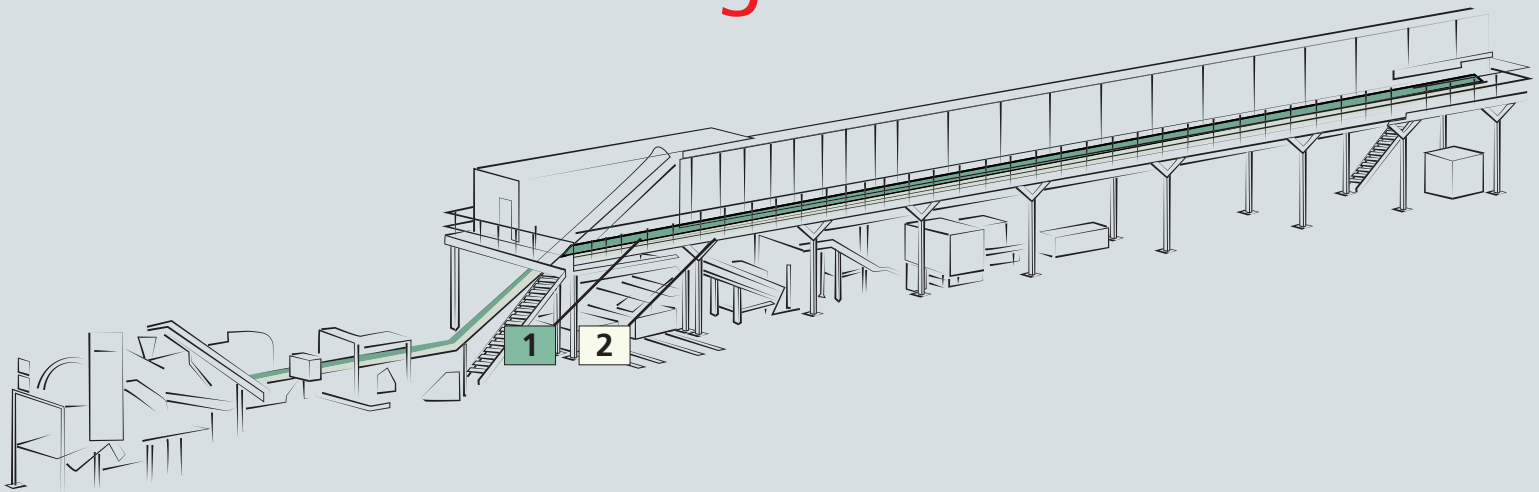

MEGADYNE® MEGALINEAR WIDE JOINED

- Synchronized conveying with low friction conveying surface
- Joining process insures perfect flatness
- T5, T10 and H pitch
- NFT offers low friction conveying surface

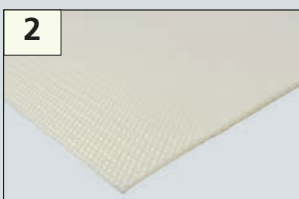

SAMPLA® FABCON

- B31 (3F/14 PG35 U0/U0)- R13 (2LR/6 TR10 U0/00 AS FA) - R16 (2R-RX/14 TR15 00/00 AS FA) - R30 (3FC/8 TR30 00/00 FA)
- Abrasion and cut resistant
- Used in applications where product accumulation occurs
- Conveyor belts with excellent release properties suitable for rubber mixture conveying
- Reinforced with cotton fabric, polyester fabric
- Water saturation if required

CASE STUDIES

Application:

Roller system for heavy duty van frames.

Previous drive:

Rubber flat belts

Previous drive problems:

High quantity of dust particles and necessity of frequent maintenance

Solution:

PS4.8 eliminated the problem of the powder and increased significantly the lifetime of the belt. The customer did not report failures and strongly reduced the maintenance actions



Application:

Vacuum conveying systems.

Previous drive:

Polyurethane standard belt joined T20 with 85 ShA PU overthickness

Previous drive problems:

Low resistance to synthetic oils used in the application

Solution:

Special polyurethane cover made in high chemical resistance material. Megadyne increased of five times the resistance and the lifetime of the belts in the same conditions.



BELARUS

Minsk
Phone +375 17 2802486
Info.ee@megadynegroup.com

BRASIL

Sorocaba
Phone +55 15 2101 7700
inquiries@jasonindustrial.com

CANADA

Edmonton
Phone: +1 780 461 4400
inquiries@jasonindustrial.com

Montreal

Phone: +1 514 31 2341
inquiries@jasonindustrial.com

Toronto

Phone: +1 905 602 4400
inquiries@jasonindustrial.com

CHINA

Beijing
Phone +86 10 8150 7478
info.cn@megadynegroup.com

Foshan

Phone +86 757 83815530
info.cn@megadynegroup.com

Fujian

Phone +86 595 8816 0309
info.cn@megadynegroup.com

Ningbo*

Phone +86 574 8650 2886
info.cn@megadynegroup.com

Qingdao*

Phone +86 532 8765 2117
info.cn@megadynegroup.com

Shanghai

Phone +86 21 5447 1473
info.cn@megadynegroup.com

Shenyang

Phone +86 24 2572 3238
info.cn@megadynegroup.com

COLOMBIA

Cartagena
Phone: 011 57 313 501 5397
inquiries@jasonindustrial.com

CZECH REPUBLIC

Prague
Phone +420 2 8481 7181
office.cz@megadynegroup.com

FRANCE

Paris
Phone +33 1 6079 8200
info.fr@megadynegroup.com

St. Jean De Maurienne*

info.fr@megadynegroup.com

GERMANY

Borchen
Phone +49 5251 8735 0
info.de@megadynegroup.com

Elchingen*

produktion@megadynegroup.com

HUNGARY

Budapest
Phone +36 23 428 628
info.hu@megadynegroup.com

ITALY

Turin*
Phone +39 011 926 8052
info@megadynegroup.com

Milan*

Phone +39 039 689 601
info@samplabelting.com

MEXICO

Mexico C.P.
Phone +52 55 5587 3680
inquiries@jasonindustrial.com

POLAND

Bydgoszcz*
Phone +48 52 348 77 12
info.pl@megadynegroup.com

SOUTH AFRICA

Johannesburg
Phone +27 (0)12 661 1652
info.sa@megadynegroup.com

Cape Town

Phone +27 (0)21 9820772
sales.za@megadynegroup.com

SPAIN

Barcelona*
Phone +34 93 811 5450
info.sp@megadynegroup.com

SWEDEN

Kristianstad
Phone +46 10 1309600
info.se@megadynegroup.com

THAILAND

Bangkok
Phone: +66 (0) 27115477
info.apac@megadynegroup.com

TURKEY

Izmir*
Phone +90 232 877 07 00
info@rultrans.com.tr

U.K.

Birmingham
Phone: +44 1384 215 021
sales@megadynegroup.com

U.S.A

California
Phone +1 323 265 8061
inquiries@jasonindustrial.com

Florida

Phone +1 813 241 4111
inquiries@jasonindustrial.com

Georgia*

inquiries@jasonindustrial.com

Illinois

Phone: +1630 752 0600
inquiries@jasonindustrial.com

New Jersey Americas HQ

Phone +1 973 227 4904
inquiries@jasonindustrial.com

New York*

Phone +1 716 667-7450
info@sampla.com

North Carolina*

inquiries@jasonindustrial.com

Oregon

Phone +1 888 231 7224
inquiries@jasonindustrial.com

South Carolina*

inquiries@jasonindustrial.com

Texas

Phone +1 972 438 6992
inquiries@jasonindustrial.com

HEADQUARTERS**ITALY Turin**

Via S. Lucia, 114
10075 Mathi (Torino)
Phone +39 011 926 8052
info@megadynegroup.com

www.megadynegroup.com

www.jasonindustrial.com

www.samplabelting.com